

METALSISTEM[®]

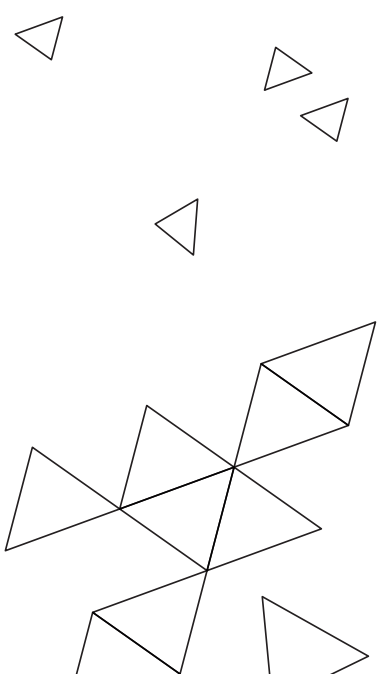

Patented modular structures

SUPER 1-2-3



Index

Production facilities	4
METALSISTEM: yesterday, today, tomorrow	5
Acting Green	6
METALSISTEM business	9
Product certifications	10
The Product	15
Basic components	16
Frames	16
Bases	16
Beams	17
Shelf panels	17
Modular containers	18
Glass/Wooden aesthetic solutions	18
Corner solutions	18
Stabilisation systems	18
Accessories	19
Tubular spacer bars and oval beams	19
Wire hooks	19
Tyre storage	19
Label holder	19
Dividers	20
Plastic containers with dividers	21
Modular drawers	22
Cladding panels	22
Cover sheet	22
Doors	23
Modular steel cabinets	23
Mobile ladders	24
Gravity	24
Mobile base systems - Compact shelving	25
Mobibasic	25
Mobieasy	25
Mobifront	26
Photogallery	27

Production facilities

Rovereto



Viale dell'Industria, 2 - 38068 Rovereto (TN) - Italia



Viale del Lavoro, 3 - 38068 Rovereto (TN) - Italia



Viale Caproni, 50 - 38068 Rovereto (TN) - Italia



Viale del Lavoro, 1 - 38068 Rovereto (TN) - Italia

Rovereto - R&D Department



Via Marconi, 3 - 38068 Rovereto (TN) - Italia

Gussago



Via Mandolossa, 100 - 25064 Gussago (BS) - Italia

Gambara



Villaggio Europa, 8 - 25020 Gambara (BS) - Italia

Motta di Livenza



Via Friuli, 32 - 31045 Motta di Livenza (TV) - Italia

Customised Modularity.
Since 1970

Follow us on   

METALSISTEM: yesterday, today, tomorrow

Founded in **1970**, METALSISTEM commenced its activities specialising in the design and production of metal roll-forming machinery and the manufacture of galvanised steel profiles created for the material handling sector. This first step established METALSISTEM as the pivot around which an articulated network of companies flourished. METALSISTEM, with **headquarters in Rovereto** – Italy, is a world leader not only in the **material handling sector**, but also in **industrial automation systems, shopfitting solutions and in photovoltaic panel support systems**.

Thanks to its exceptional production capacity and sales network, METALSISTEM creates **unique leading-edge products**. Continuous research in new production technologies creates products that are ideally suited for safe exhibition and storage spaces.

The great versatility of METALSISTEM components, combined with their nimble application, facilitates the erection of modular systems which are able to both fully satisfy the customer's need and follow the evolutionary developments of the sector.

A system which is **modular, functional and simple in application**: these are the core ideals of the original concept that gave birth to an articulated range of storage and archiving systems. Every product is defined by **superior structural performance** while ensuring **high standards of quality** that are recognised by the most important European controlling bodies.



Discover



more

Quality, Excellence, Service

our strength points in the challenge of competitiveness



Acting Green

Green is a business success driver

One of the main levers that make METALSISTEM a competitive company is its **green soul**. Success in today's business environment follows an **eco-sustainable path** able to build true growth into the future.

Green development is possible! METALSISTEM wants to demonstrate its leadership by making **sustainable choices** for the benefit of the planet: operating a green

business means creating both environmental and economic value.

METALSISTEM products are developed with a green conceptual purpose of avoiding the waste: **a galvanised finish provides high levels of durability; highly modular structural components** ensure versatility and may be easily replaced without requiring the substitution of the entire structure.

Solar panels The energy for tomorrow



A clean energy business model with **zero** environmental impact

75%
ENERGY SELF
SUFFICIENCY

Tech data:



2'747

Power (kW)



2'900

Production Output (MWh/year)



11'636

Panels (235/240 W)



168

Inverters



38'677

Roof Area (m²)



75%

Energy self sufficiency

The METALSISTEM switch to renewable power demonstrates to customers, shareholders and the broader community its commitment to sustainability. To date, METALSISTEM has reached **75% energy self-sufficiency** through the application of almost 12'000 photovoltaic panels installed on the rooftops of its facilities. This translates to an area of 38'677 m² covered

by photovoltaic panels which produce 2'900 MWh per year. Representing a **reduction in Carbon Dioxide emissions of 1'622 tons**. This really means playing a responsible and tangible role in the climate-change challenge by building a successful self-sustaining business model targeting **ZERO emissions and ZERO environmental impact**.



Discover more

Recycling overview

Recast structural steel

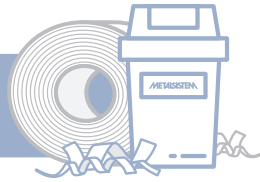

Raw material efficiency

USE OF RECYCLED STEEL

It may sound cliché, but recycling is the most natural and effective method of lightening the impact of economic activity on the environment.

METALSISTEM has always been interested in the philosophy of the recycling processes, to **reduce waste and save energy**. However, the green ambitions of METALSISTEM do not end with day to day **recycling activity**. The company **recycles metal off-cut** generated from the steel production process and

employs high tensile **recast structural steel**, which reduces the exploitation of the earth's mineral resources. METALSISTEM in this way gives its contribution to the "circular economy," because new production technologies and methods are now able to create high-quality recast structural steel with superior properties while simultaneously saving energy, territorial resources, and mineral movement.

Green manufacturing

Industry that cares for the environment



Green industry

ZERO IMPACT!

METALSISTEM is focused on **minimising the impact that manufacturing has on the environment**. This requires a sharper view of the production process and its pollution emission levels.

The same foresight had directed the company towards the exclusive development of **galvanised products** to facilitate the minimisation of welding and painting processes, which reduce both air emissions and gas consumption.

A company's environmental performance not only depends on the industrial process but also on the ecological footprint that its products generate in its lifetime. METALSISTEM chooses an environmentally friendly approach for its products' finish.

Thanks to the galvanization process, METALSISTEM products preserve against corrosion and ensure greater durability over time.

Eco-consciousness

Reduction of paper and plastics



Sustainable consumption

REDUCE, REUSE, RECYCLE

METALSISTEM's environmental concerns are also addressed through small everyday activities that bring long term results through **more sustainable use of paper and plastics in the workplace**. Businesses can play an important role in the reduction of plastic pollution into the environment.

Plastic use at METALSISTEM is kept to a minimum through initiatives undertaken in the production and office facilities; for example, providing its staff **reusable bottles, drinking fountains and proper plastic waste recycling**.

Moreover, METALSISTEM increasingly adopts **paperless electronic procedures**, uses **recycled paper** at its offices and has paper recycling procedures in place - all which contribute to the preservation of this precious resource.

Eco-conscious use of paper and plastics saves energy, whilst the implementation of recycling activities saves resources and reduces waste.

SUPER 1-2-3
Patented bottless hand loaded system



 Storage systems



Shopfitting 



 Green Energy



Indoor
& Outdoor Furniture 

METALSISTEM business

Quality, Excellence, Service

METALSISTEM business is based on three foundational values: quality, service, excellence. This motto is applied to all METALSISTEM activities:



Storage systems

Storage & Material Handling



Shopfitting

Retail Display & Shopfitting



Green Energy

Photovoltaic Support Systems



Indoor & Outdoor Furniture

Furnishing Concepts

Versatility and **compatibility** are hallmarks of these business centres which are able to interact with each other to open up to new possibilities for future solutions.



Reference standards and Product certifications

Quality is a corner stone of the METALSISTEM philosophy. A state of mind applied right from the supply of the structural steel coils by the worlds largest steel mills. Only prime quality 3.1 certified high tensile steel coils conforming with the EN 10204 standards are used for the manufacture of the METALSISTEM product range. The steel coils are galvanised through the **SENDZIMIR**

procedure which guarantees both **high levels of durability and elevated corrosion resistance.**

Unique production technologies, developed with METALSISTEM's own Research & Development Centre from the backbone of a technologically advanced manufacturing process that is part of all METALSISTEM components.

Certification Standards

Quality, Safety and other Certification systems



ISO 9001:2015
Quality assurance
certification



ISO 14001:2015
Environmental management
systems certification



OHSAS 18001:2007
Health and Safety
system certification



Discover more



EN 1090-1:2009/A1:2011
CE Marking
Factory production
control



**"AEO" – Authorized
Economic Operator**
Customs "AEO" FULL
authorisation



UNI EN ISO 3834-2
Welding processes
certification

Product Certification Standards

Certifications and norm compliance per product category

Industrial racking
and shelving



TÜV
Product
certification



CISI
Quality and Safety
trademark

Shopfitting shelving

METALSISTEM is currently carrying out test series on its display shelving product range, to obtain certification and compliance with the UNI 11262 standards.

Checkout
counters



2006/42/CE
In compliance with
the European directive
2006/42/CE on
machinery



2014/35/CE
In compliance with
the European directive
2014/35/CE on electrical
equipment design



2014/30/CE
In compliance with
the European directive
2014/30/CE on electromagnetic
compatibility

Other certifications and approvals

Authorisations and other approvals with external institutions

Accreditation with the “SERVIZIO TECNICO CENTRALE”

METALSISTEM has been qualified as a processing centre in possession of all the requisites for steel manufacturers n° 753/10.

Quality in the selection of raw materials

Prime quality 3.1 certified high tensile steel coils conforming with the EN 10204 standards. SENDZIMIR galvanised steel for high levels of durability and elevated corrosion resistance.

Model organization and control

According to the Italian legislative decree D.LGS 231/2001, applied from December 2009.

Certifications regarding personnel

Welder qualifications according to UNI EN ISO 9606-1:2017 and UNI EN ISO 14732:2013.

The welding process applied by METALSISTEM is in conformity with the UNI EN ISO 3834-2 standards.

Electrical Installations

Authorized to operate according to the Italian legislative decree D.LGS 37/2008 guaranteeing the safety of electrical installations.

Memberships and collaborations

Cooperations and other forms of partnerships with external bodies

Association of Italian steel fabricators; chapter of Industrial Racking - CISI

METALSISTEM is a member of the steering committee and of the study group. As METALSISTEM has fully complied with the self certification program it is authorised to use the CISI label.

I.S.P.E.S.L. - Istituto Superiore per la Prevenzione e la Sicurezza del Lavoro

Institute for Occupational Health and Safety - tests conducted on full scale structures.

Università di Trento

Structural Engineering: beam/upright connection stiffness, stub column and foot plate deflection tests.

Polytechnic University of Milan

Full scale tests on industrial racking under static and seismic conditions.

F.E.M.

Fédération Européenne de la Manutention.

AISEM - ANIMA - CISI is the official Italian representative of F.E.M.

Metalseismic Test Tower

Seismic testing permanent laboratory

Metalseismic Test Tower, a purpose built permanent laboratory dedicated to the “Metalseismic” seismic testing project, within which innovative solutions are developed for seismic resistant structures.



Discover more



Aimed at research and development of innovative solutions for seismic-resistant structures, the project stands out for its high scientific relevance and its worldwide unique purpose in approach, size and load tests.

						
25 metres	12x12 metres	20 ton	24 ton	80 ton	1700 ton	1400 m³
Structure height	Square footprint	Lateral resistance	Maximum hung loads	Structure total weight	Maximum axial load bearing capacity	11 inspection levels with instruments



Boltless shelving system!
fast assembly

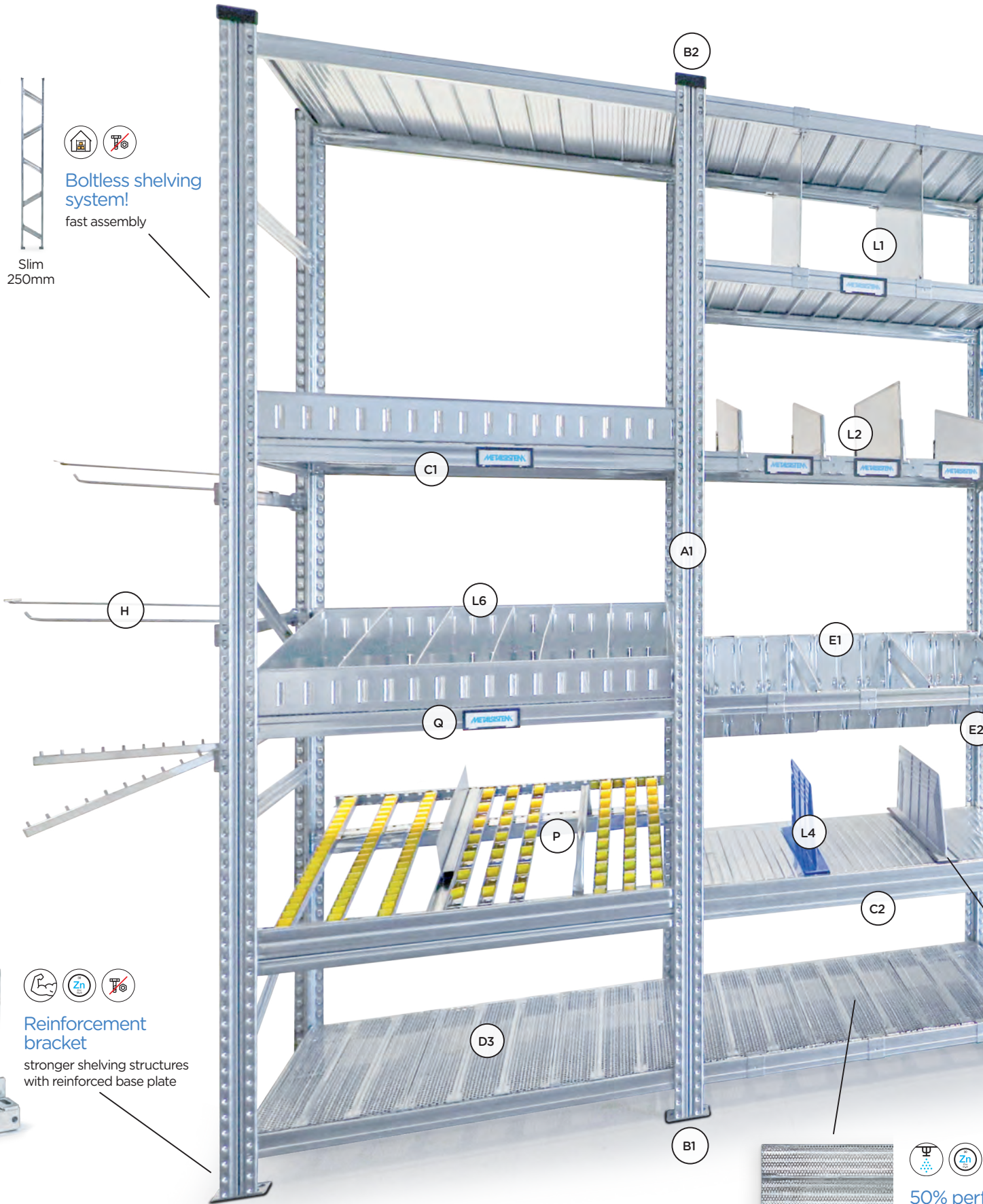

B3



Reinforcement bracket

stronger shelving structures with reinforced base plate



50% perforated shelf panel
compatible i



 **Lock for drawers**
a safer system!

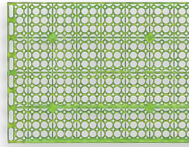

Frost
sub-zero environments?
perfect for the frost shelf panel!



Cladding systems
compatible with
Euroscacco accessories



perforation
panel for sprinkler
compatible installations



Magnetic!
perfect grip
without clips!

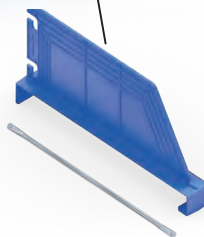

Plastic!
a colourful, resistant,
practical lightweight divider



Cladding systems
galvanised or
powder coated
finishes

Discover more



The Product

Patented boltless hand loaded system

The key features of the fully adjustable Super 1-2-3 system have evolved from rigorous technical testing matched with a highly specialised knowledge of metal processing, developed over the years.

This experience has enabled METALSISTEM to create a highly technical product, ideally suited to solve the most common shelving problems: stability, high load bearing capacity, rapid assembly.

Versatility

The strengths of the Super 1-2-3 system can be summarised in just a few concepts; a versatile product by definition, able to offer a wide range of standard accessories made to stock countless types of different items, both loose and packaged.

The ability to create 90° corner solutions optimises storage volumes while the 33mm adjustable pitch permits Super 1-2-3 to optimise warehousing in height.

The presence of reinforcing ribs allow for a maximum performance with a minimal use of raw material, according to METALSISTEM green purposes.

The structural characteristics of Super 1-2-3 make it ideally suited for heavy-duty shelving applications, not to mention two and three tier suspended walkways up to a maximum height of 5 meters.

Durability and safety

Product safety is a METALSISTEM priority; Super 1-2-3 structural components are made from high tensile structural steel, while high quality galvanisation ensures product durability and elevated corrosion resistance.

The safety standard of the Super 1-2-3 series is recognised by TÜV, Germany's quality certification body. In addition, the advanced manufacturing process used by METALSISTEM guarantees both production capacity and fast delivery for all components.

Aesthetic value

Thanks to an attractive high-tech design, Super 1-2-3 shelving is sleek and pleasing to the eye. Well suited to provide unique solutions for applications ranging from shopfitting or domestic environments right through to workplace uses.

The Super 1-2-3 profile has a clean and tidy look, making it suitable even for goods showcasing.

Price quality ratio

The 50 years experience of METALSISTEM in the material handling sector, has pushed the company to move towards rigorous research into materials.

This translates to higher performances, an optimised use production materials, ease of application and use.



boltless



33mm
upright pitch



galvanised
finish



hand loaded
storage



90° corners



Basic components

Frames **(A)**

General characteristics:

Uprights **(A1)**

The versatility of the Super 1-2-3 upright profile ensures the greatest range of flexibility making it ideal for countless fields of application.

Frame bracing **(A2)**

The frame bracing plays a very important role in absorbing the shelving horizontal actions. The combination between diagonals and spacers, fast and nimble to assemble, allow the Super 1-2-3 to offer high structural performances. In addition, diagonals are equipped with safety clip elements that provide stability to the structure.

Super 1-2-3 structures can reach up to a maximum height of 5 meters and 800mm of depth.

Wall fixing and double-side configurations

By using an appropriate fixing bracket, it is possible to fix the shelving to the wall. Shelving may also be assembled in double-side configurations (back to back).

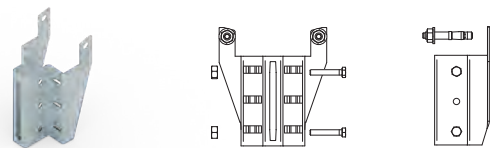
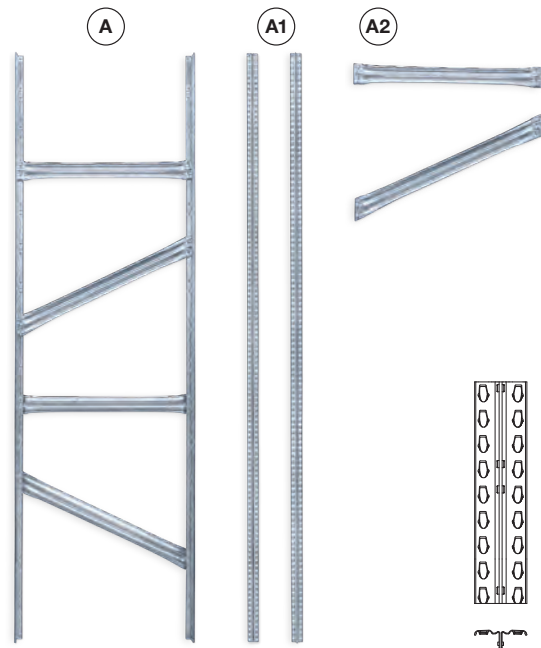

Bases plates **(B)**

Bases plates are fundamental structural elements which both anchors and distributes the upright's load to the floor thus ensuring the safety of the shelving system. In order to satisfy even the most demanding needs, METALSISTEM offers three different types of interlocking bases:

Standard base **(B1)**

The metal base plate provides upright structural integrity and permits anchoring of the shelving system to the floor. Available in different thicknesses depending on the characteristics of the ground.

Plastic base **(B2)**

Versatile component for furnishing applications that may also serve as upright top cap. It may be used as well for domestic environment applications.

Base reinforcement bracket **(B3)**

Coupled with the standard Super 1-2-3 base plate, the reinforced base represents a highly functional component that offers an excellent solution and provides excellent structural performances.

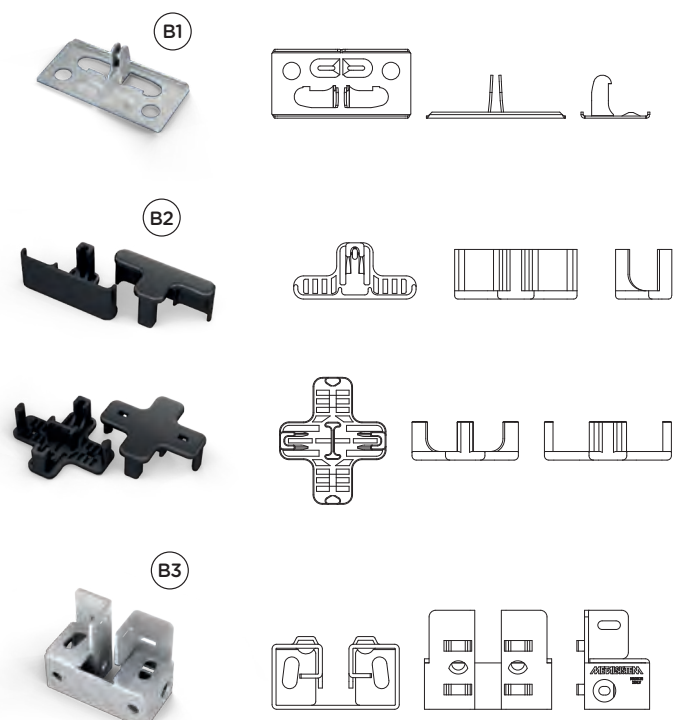

Beams ^(C)

In addition to carrying the load, beams permit a wide range of accessories to be applied to the Super 1-2-3 system in tune with the diverse user needs:

Super 1-2-3 series beams ^(C1)

Super 1-2-3 G series beams for higher loads ^(C2)

In order to guarantee the safety of the structure, beams need to be equipped with safety clips.

An upper groove present on all shelving beams enables a wide variety of shelving panels and accessories to be applied to the system seamlessly and fulfill any need with ease.



Safety clips

Shelf panels ^(D)

H12 shelf panels ^(D1)

Offered in three standard widths which are combined to cover all METALSISTEM standard beam dimensions. **Depths range from 250mm to 700mm.**

H25 shelf panels ^(D2)

Offered in a standard nominal width of 300mm, this shelf is suited for **higher load bearing capacity** needs and is available in **depths ranging from 400mm to 800mm**. This panel is particularly suitable for **point load applications**.

50% perforated H25 shelf panels ^(D3)

Based on the standard H25 panel format, these contain perforations which allow the passage of air and water over 50% of the surface. This type of shelf panel is often applied to **installations equipped with sprinkler systems**.

Plastic shelf panels ^(D4)

METALSISTEM Super 1-2-3 shelving can be equipped with plastic shelf panels made from high quality polypropylene plastic which is also suited for **packaged food sector storage** needs.

Specific **frost shelf panels**, available in light green, are dedicated for **use in freezers**. Furthermore, plastic shelf panels are available in a variety of colours to help better identify goods or simply to satisfy aesthetic needs of boutique applications. Plastic panels are supplied with a 50% perforated surface which is an added benefit for a variety of applications.

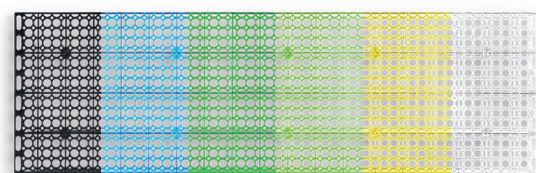
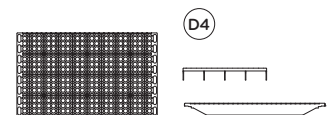
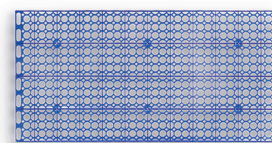
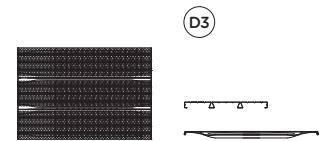
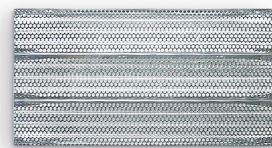
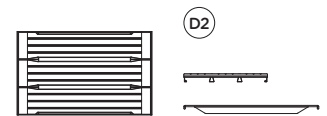

Modular containers (E)

Super 1-2-3 shelving can be supplied with modular containers which are available for all standard frame depths:

Modular containers in different sizes (E1)

These accessories are very functional and especially useful for the storage of loose parts. Containers are installed directly on the beam, fastened with safety clips and equipped with dividers which form the side walls to separate the loose items.

Shelf and modular container safety clips (E2)

Safety clips ensure that shelves and modular containers remain firm in their position. If necessary, the safety clip may also be used as a position blocking system: this enables shelves to remain spaced, thus creating 50% covered surfaces or similar applications.



Glass/Wooden solutions

Thanks to the addition of special components in the beam groove, glass or wooden panels may be fitted to the beams to gentrify the product for shop environments and alike.

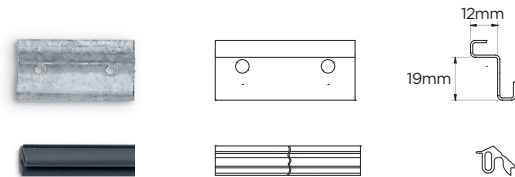

Corner solutions

Open shelving corner solutions optimise a storage facility and, for this reason, are particularly suited for small and awkward rooms. **Dedicated brackets, are used to create both left and right side corners or “T-shaped” peninsular configurations.** Limitless applications!

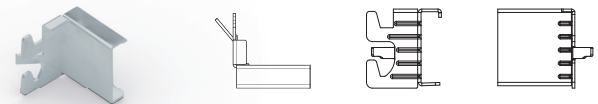

Stabilisation systems (F)

Reinforcement bar

The reinforcement bar is composed of a stiffened tubular section which is connected to the upright to **increase the stability of a row.** This product is often **seamlessly integrated into the shelving bay when used in combination with the accessory profile (F2) to permit the application of shelf panels.**

Bracing systems

Composed of turn-buckles directly connected to the uprights and stirrups which are placed in a cross. METALSISTEM offers both standard and heavy duty bracing solutions which are able to respond to any stiffening demand.

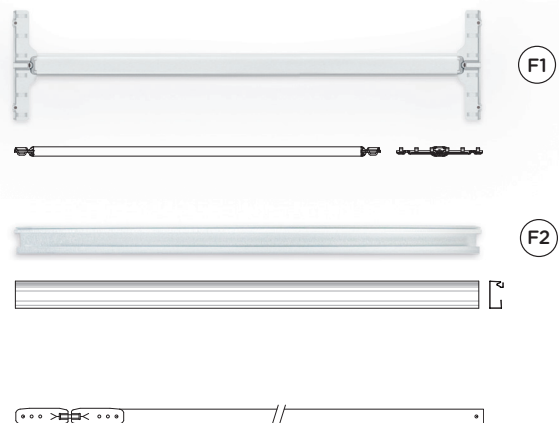

Accessories

The modular nature of Super 1-2-3, coupled with its extensive range of accessories, are the core strengths of the product. These strengths make this shelving system perfectly suited to satisfy customer demands,

ranging from industrial warehousing and e-commerce picking facilities to shop front and back store needs, right through to sole trader and domestic applications.

Tubular spacer bars and oval beams G PIC 09

These accessories are ideal to implement garment on hanger solutions; oval tubes can be fitted directly to upright at 33mm pitch height intervals or placed on frame spacers within the shelf footprint at a 50mm pitch.



Hooks H PIC 01

Oval beam accessories available in a wide range of wire and tubular hooks.

This solution allows the stock to be hung front facing. Wire hooks are also suited for goods stocked in blister packs.

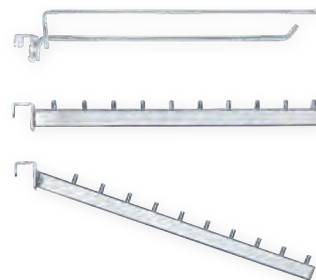

Tyre storage I

Oval beams are a very versatile product that is well suited to a wide variety of applications which include tyre storage.



Label holder Q PIC 12

It can be located in any position on both H47 and H80 beams.



Dividers (L)

The large range of dividers offered by METALSISTEM granularly responds to customer needs.

Especially useful for the spare parts service sector, dividers may be:

Fixed height dividers (L1) (PIC 03)

Supplied in three standard heights (244mm – 344mm – 444mm). Clips, placed on the shelf level beams provide a fixing point to which the fixed height dividers can be inserted. The application of this accessory enables shelving to be divided into **pigeon holes**; the extended surface area of the fixed height dividers permits the application of **labelling** and other forms of **high visibility identification solutions**.



Sliding dividers (L2) (PIC 10)

Applicable also to assembled installations, these can be repositioned on the beam. The sliding dividers are supplied in three standard configurations in height: **100mm, 200mm** rectangular dividers or **trapezoidal** dividers (front 100mm, rear 200mm).

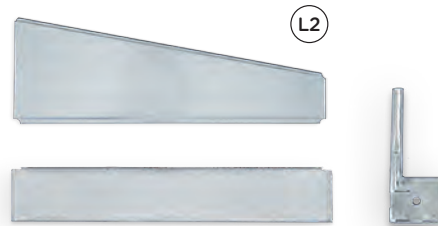

Plastic dividers (L3) (PIC 06)

Available in blue, black or grey, these ensure a **marked and defined compartmentalisation** of products; made from light and flexible yet **sturdy mineral charged polystyrene**, this divider has a simple and fast clip-on/clip-off application and is available for shelf depths ranging **from 320mm to 600mm**, for H47mm and H80mm beams at a standard height of 200mm.

They may be integrated with a tubular backstop profile (L5) to prevent items from rolling back of the shelf.

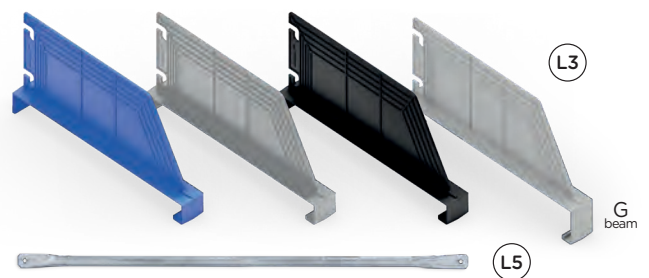

Magnetic plastic divider (L4)

Available in blue, black or grey, these ensure a marked and defined compartmentalisation of product.

The magnetic plastic dividers, available in the same depth range as the plastic divider, are applied effortlessly to the shelf surface and can be easily repositioned or relocated. They may be integrated with a tubular backstop profile to prevent items from rolling back of the shelf.

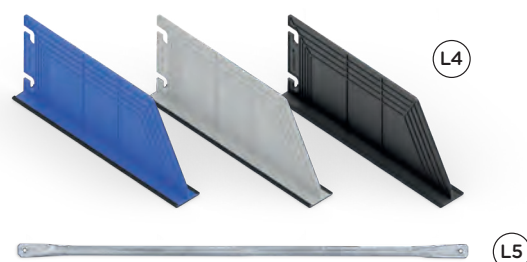

Shelf trays L6

These use 100mm and 200mm high panels placed on the front and rear beam to provide connection points for dividers and create well defined configurations, allowing **shelves to be separated both in length and depth.**



Telescopic tube dividers L7 PIC 05

Used for the storage of components which are otherwise difficult to store such as **cylindrical components, long items or unusually shaped material.** Thanks to the use of beam fitted brackets, telescopic tubular dividers can be extended out to the upright line, allowing the entire depth of the load level to be exploited.

These accessories are used to separate items such as **tubes, exhaust pipes or rods** and are supplied for both vertical and horizontal division.

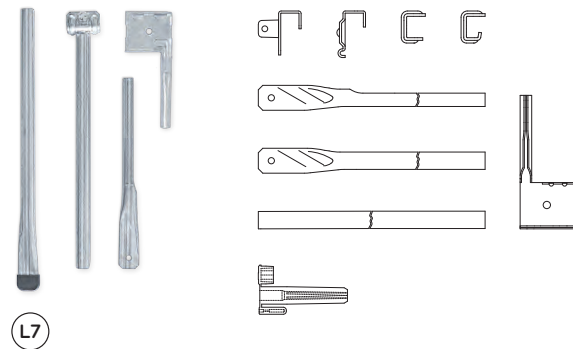

Plastic containers with dividers L8 PIC 04

Made of **impact resistant plastic**, open front plastic containers are **stackable** and are **light yet strong.** METALSISTEM offers this product in a large range of colours, a useful feature which can be used to **customise specific warehouse areas or better identify product categories.**

Containers both facilitate hand picking operations and can be easily positioned where needed.



Modular drawers (M) PIC 07

Completely integrated to the Super 1-2-3 system, this accessory is fixed directly to the frame.

Drawers may be supplied with dividers in order to better organise the storage of small items.

Furthermore, drawers can be equipped with key locks.

As with all other Super 1-2-3 accessories, the drawers are modular and are **available in the following standard heights: 66mm – 99mm – 165mm – 264mm – 363mm.**

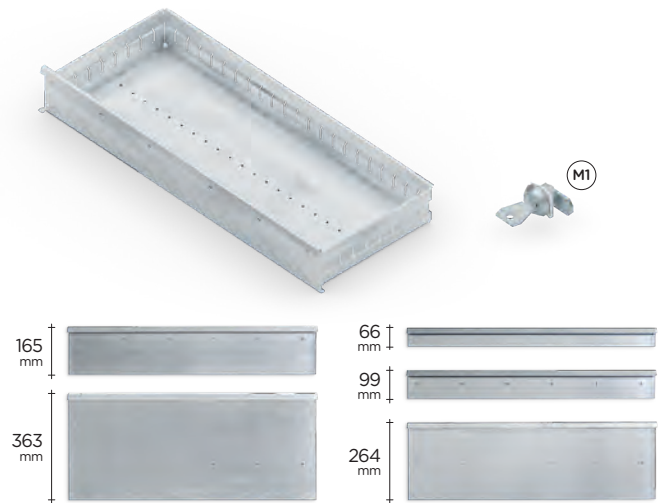

Cladding panels (N) PIC 08

Super 1-2-3 cladding panels are supplied in different variants: lateral, intermediate, frontal, back to back, perforated and head frame slatted cladding. Panels may be galvanised or powder coated. These cladding panels are useful both for their ability to **isolate stored goods** from the surrounding environment as well as for their **aesthetic value**, making them ideal both for industrial and commercial applications.

Cladding applied to the rear of single side rows are made up standard panel modules which completely cover the shelving structure. Intermediate and side frame cladding panels, available for depths ranging up to 600mm, are also available to finish the cladding system and to prevent lateral access.

In addition, when combined with the head frame slatted cladding, intermediate cladding panels can create a sheltered space between the panels which is suitable to hide power cables.

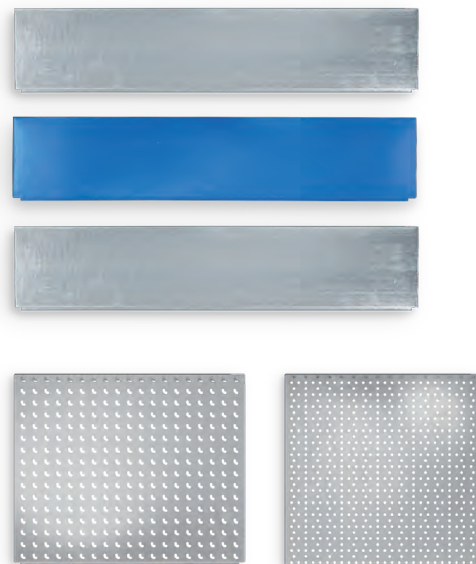

Cover sheets (O)

An innovative solution to create **smooth loading surfaces**. The cover sheet is an elegant and easily cleaned accessory which is placed over standard H12 or H25 shelf panels. The cover sheets are supplied in two variants: **flat, ideal for unstable items such as bottles, pots or spray cans** thanks to its flush and smooth surface, or **with a 100mm high back lip to prevent small items from rolling off the back of the shelf.** Both solutions are available in standard or “heavy duty” variants which are best suited for point load applications such as electric motors, extinguishers, etc.

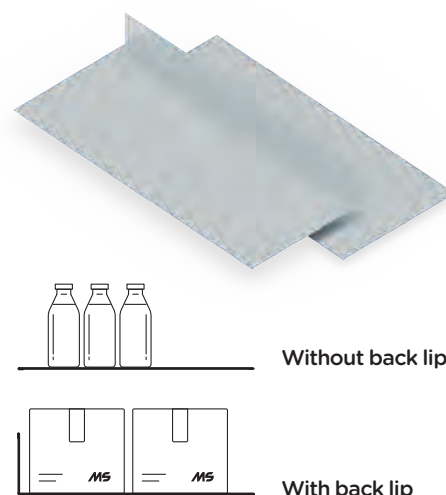

Sliding or swinging doors

Uniquely placed in the market, these **lockable sliding doors** are particularly suited for applications such as cabinets or closets as they do not unnecessarily occupy corridor space, making them ideal for tight and **awkward spaces**. Doors are supplied with painted panels in the standard METALSISTEM colour range.

METALSISTEM sliding doors are unique as they are made of up to **three interconnected sliding panels which provide an exceptional 65% opening face**.

The panels of a sliding door unit are connected in a **single locking position**. These key features make this product **versatile** and **ergonomic**.

In addition, the Super 1-2-3 shelving range can be equipped with conventional lockable swinging doors, if required.



Modular steel cabinets

Super 1-2-3 shelving is also suited to the creation of **unique and innovative modular steel cabinets** thanks to the application of standard side and rear cladding panels installed on three faces of a standard bay with the addition of sliding doors. Super 1-2-3 cabinets are available both in galvanised or powder coated finishes. Unique top cover plates elegantly complete the cabinets. **Super 1-2-3 provides class leading load bearing capacities along with access to an extensive range of standard accessories. Unparalleled features in this market.**

Its high-quality materials allow to Super 1-2-3 steel cabinets to be supplied in **widths of up to 1800mm with heights reaching 2500mm**: these are unique dimensions for this type of product!



Mobile ladders

Super 1-2-3 may also be equipped with mobile ladders able to slide across the entire length of a row. These are available in a variety of heights suited for far reaching applications.

Ladders are supplied with guide rails and, if required, **90° corner rails** that adapt these ladders to **any environment**.

Versatile, light and solid at the same time, METALSISTEM sliding ladders are fit for all Super 1-2-3 configurations: **sliding easily with effortless action**.



Gravity P PIC 02

METALSISTEM supplies an extensive range of roller profiles which are ideally suited to the Super 1-2-3 product.

Roller profiles, more frequently used in hand loaded FIFO (First In First Out) applications are commonly found in areas where **stock rotation and higher storage densities** are required.

Roller profiles are provided with plastic rollers which are fixed at a variety of standard pitches. The roller profiles rest on standard Super 1-2-3 beams which are set in order to create a constant inclination.

Standard Super 1-2-3 components are also used to form end stops and mobile or fixed separation able to extend to the full length of a lane: the result is a **low-cost functional product!**

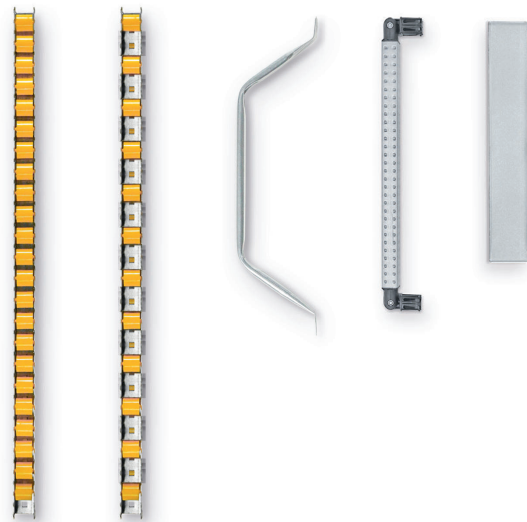



Discover more

Mobile base systems – Compact shelving

Over the years, **METALSISTEM** has continued in its search to improve product quality. One result of this activity has been the development of mobile base systems which, combined with the Super 1-2-3 shelving series, represent truly innovative archiving solutions

designed for space optimisation. METALSISTEM has created **three different compact storage solutions** in order to optimally suit the diverse customer needs: **Mobibasic, Mobieasy and Mobifront.**

Mobibasic

The Super 1-2-3 shelving is installed on trollies actioned by a patented maintenance free manual drive system running on fixed tracks. Mobibasic is available for both single and double side shelving configurations; units (rail and shelving) are moved by rotating a hand-wheel fitted to the front shelving frame.

This drive system is a stand-alone unit, **easy to install** and reliable, rendering countless access cycles effortless. This system is suitable for **indoor applications** and it is particularly valued in **archival applications**. **The very intelligent use of the surface area – a key feature of Mobibasic – makes it perfect for high-density storage structures.**

The application of the Super 1-2-3 shelving system onto the structure means that the **full range of METALSISTEM standard accessories is available for a wide range of uses.**



Mobieasy

Ideal for applications in tight spaces and fully compatible with the Super 1-2-3 shelving system, the Mobieasy solution is composed of top rail guided trollies with rubber capped wheels.

Floor rails are also available for **smooth function** and floor protection. **A key feature of the Mobieasy system is that it does not require floor fixing, making it ideally suited for application over finished floor surfaces.**

Mobieasy systems are hand operated units generally applying row lengths of up to two bays.

The application of the Super 1-2-3 shelving system onto the structure means that the **full range of METALSISTEM standard accessories is available for a wide range of uses.**



Mobifront

Traditionally, mobile base solutions access bays by **opening corridors between rows.**

Mobifront tilts this concept on its head, maintaining the installation compact by pulling the bay out into the main access corridor. A unique solution that both increases **accessibility and storage density.**

Floor guide rails remain hidden beneath the bays, leaving installation access clear from hindrance.

Mobifront is a clad single bay application, well suited for office environments and the shop floor alike.

A key advantage of this solution is that **full access to both faces of the bay are given when a unit is pulled open,** ideal for the logical placement of goods.

The compact nature of this solution makes it particularly adaptable for spaces such as wide **corridors, blind corners and alike.**



Shopfitting Solutions



Material Handling



Mezzanines and Two Tier Structures



Other applications

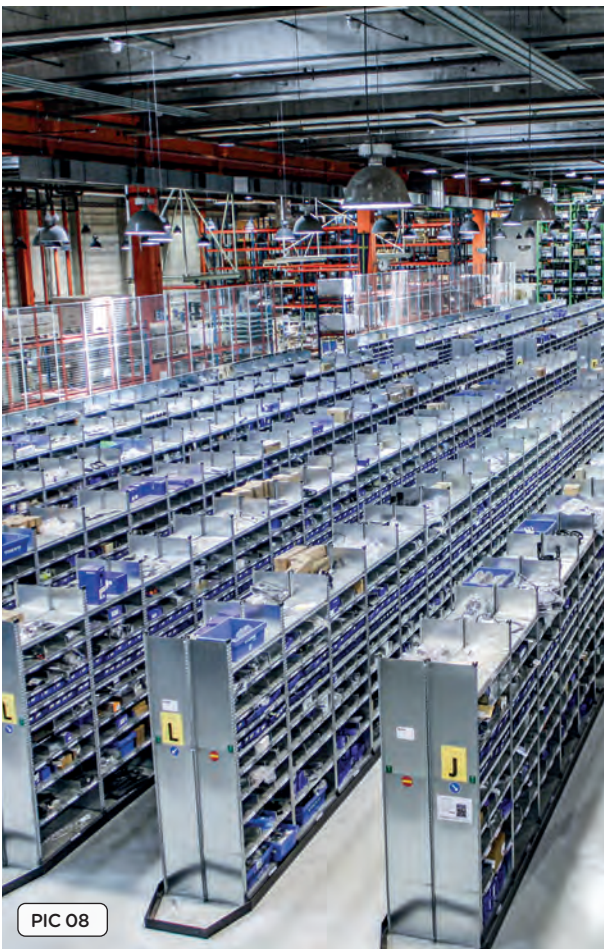

Other applications

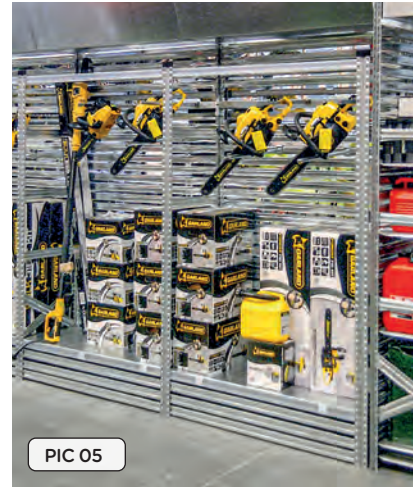

Other applications



METALSISTEM Group

Contact us



SERVICES



121 Granton Drive, Unit #21
Richmond Hill, ON, CANADA, L4B 3N4
Tel. +1 905 8869499 | Fax +1 905 8866890
info@metalsistemcanada.com
www.metalsistemcanada.com



9B International square,
Tullamarine, VIC, 3043 - AUSTRALIA
Tel. +61 03 9310 5939 | Fax +61 03 9310 5930
info@metalsistemaustralia.com
www.metalsistemaustralia.com



3201 Fox St.
Philadelphia, PA 19129 USA
Tel. +1-866-412-5558 | Fax +1-905-866-6890
info@metalsistemnorthamerica.com
www.metalsistemnorthamerica.com



Via Gaggiolo, 27
6855 Stabio - SWITZERLAND
Tel. +41 91 210 32 99
info@metalsistem.ch
www.metalsistem.ch



Rue de l'Industrie, 4-6
Z.I. L-8399 Windhof - LUXEMBOURG
Tel. +352 39 72 06 | Fax +352 39 92 30
info@luxmetalsistem.eu
www.luxmetalsistem.eu



Portgatan, 3 - Postbox 45
632 20 Eskilstuna - SWEDEN
Tel. +46 16-551 22 90
info@metalsistem.se
www.metalsistem.se



Rue Leonard de Vinci, 11
Z.I. Du Parc 91220 Le Plessis Paté, Paris - FRANCE
Tel. +33 1 60851845 | Fax +33 1 60849554
info@sidacsystem.fr
www.sidac-metalsistem.fr



C/Narcis Monturiol nº 4 nave 14
08110 Moncada | Reixac, Barcelona - SPAIN
Tel. +34 935 651 800 | Fax +34 935 651 801
sidac-iberia@sidac-iberia.com
www.sidaciberia.com



Viale del Lavoro, 1
38068 Rovereto (TN) - ITALY
Tel. +39 0464 486124 | Fax +39 0464 400430
info@metalsistemitalia.it
www.metalsistemitalia.it



Viale del Lavoro, 1
38068 Rovereto (TN) - ITALY
Tel. +39 0464 303290
info@metalsisteminternational.com
www.metalsisteminternational.com



Via Friuli, 32
31045 Motta di Livenza (TV) - ITALY
Tel. +39 0422 861939
info@sidacinternational.com
www.sidacinternational.com



Viale del Lavoro, 1
38068 Rovereto (TN) - ITALY
Tel. +39 0464 303400
info@italiaingegneria.it



Via C. Marx, 113
41012 Carpi (MO) - ITALY
Tel. +39 059 696450 | Fax +39 059 642479
info@metalsistememilia.it
www.metalsistememilia.it



Via Pontarola, 13/B
35011 Campodarsego (PD) - ITALY
Tel. +39 049 9201696 | Fax +39 049 9201236
info@metalsistemline.it
www.metalsistem.com



Via E. Fermi, 6
20090 Buccinasco (MI) - ITALY
Tel. +39 02 45708646 | Fax +39 02 45708647
info@metalsistemlombardia.it
www.metalsistemlombardia.it



Via Maestri del Lavoro, 17
60028 Osimo Stazione (AN) - ITALY
Tel. +39 071 7108660 | Fax +39 071 7108485
info@metalsistemmarche.com
www.metalsistemmarche.it



Via Ponza, 3
80026 Casoria (NA) - ITALY
Tel. +39 081 5843288
info@metalsistemnapoli.com
www.metalsistemnapoli.com



Via Torricelli, 39
10028 Trofarello (TO) - ITALY
Tel. +39 011 6497569 | Fax +39 011 6498469
info@metalsistempiemonte.com
www.metalsistempiemonte.com



Via dei Castelli Romani, 56/58
00040 Pomezia (RM) - ITALY
Tel. +39 06 91801333 | Fax +39 06 91621141
info@metalsistemroma.it
www.metalsistemroma.it



Z.I. Predda Niedda Nord, str. n. 3
07100 Sassari (SS) - ITALY
Tel. +39 079 260559 | Fax +39 079 2633604
info@metalsistemсарdegnа.com
www.metalsistemсарdegnа.com



Via del Lavoro, 16
63076 Montepandrone Centobuchi (AP) - ITALY
Tel. +39 0735 704880 | Fax +39 0735 710413
info@blocksystem.it
www.blocksystem.it



Via Quinta Casa, 6
90142 Palermo (PA) - ITALY
Tel. +39 091 547674 | Fax +39 091 547674
glsystem@inwind.it
www.glsystem.com



Via Monte Leone, 25
21013 Gallarate (VA) - ITALY
Tel. +39 0331 793619 | Fax +39 0331 770407
info@luonisistem.it
www.luonisistem.it



Via Donatori del Sangue, 5/II
31020 Fontane di Villorba (TV) - ITALY
Tel. +39 0422 911994 | Fax +39 0422 912085
info@sidacveneto.com
www.sidacveneto.com



Via Maestri del Lavoro n.c. - Z.I.
70017 Putignano (BA) - ITALY
Tel. +39 080 4054154 | Fax +39 080 4054143
info@smetar.it
www.smetar.it



Via del Pratignone, 70
50041 Calenzano (FI) - ITALY
Tel. +39 055 887 36 33 | Fax +39 055 8874652
info@soteasistem.com
www.soteasistem.com



Via Tito Baresani 13/15
25124 Loc. Fozzano (BS) - ITALY
Tel. +39 030 266508 | Fax +39 030 2160301
info@teknosistem.it
www.teknosistem.it



Via dell'Artigianato, 24
37060 Caselle di Sommacampagna (VR) - ITALY
Tel. +39 045 8581212 | Fax +39 045 8581166
info@vierresistem.it
www.vierresistem.it

PRODUCTION



STORAGE AND MATERIAL HANDLING SOLUTIONS



INDUSTRIAL AUTOMATION AND MACHINERIES



RETAIL TRADE SOLUTIONS



SHOPFITTING AND FURNISHING CONCEPTS

Download



the catalogue

METALSISTEM

1970 | 2020

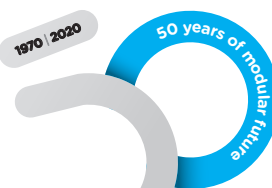

SIDAC



METALSISTEM®
STRUTTURE ED AUTOMAZIONE
MADE IN ITALY

METALSISTEM S.p.A.
Viale dell'Industria, 2 - 38068 Rovereto (TN) - Italy
Tel. +39 0464 303030 - Fax +39 0464 303031
info@metalsistem.com - www.metalsistem.com

VERSION 00 | PRINT DATA 09/2020 | CODE ING665RCS000.98